



135 Region South Dr, Jackson, GA 30233  
www.bgequip.com  
800-544-8811 • Fax 678-688-5633

# Parts List & Maintenance Manual

## CORROSION RESISTANT ACID SERIES

### CAUTIONS FOR SAFE OPERATION

- Read Owner's Manual completely before operating this sprayer.
- Always wear safety goggles, gloves and protective clothing while using this sprayer.
- Do not leave sprayer in the sun, when not in use.
- Never use flammable liquids in this tank.
- Never store spray material in this tank.
- Always release pressure when sprayer is not in use and before removing pump from tank.
- Read and follow all instructions and cautions on label of chemical spray material to be used.
- Clean and rinse sprayer thoroughly after each use.
- Never attempt to alter sprayer from original condition.
- Always use replacement parts from original manufacturer.

### WARNING

IMPROPER USE OR FAILURE TO FOLLOW INSTRUCTIONS CAN RESULT IN EXPLOSIVE FAILURE WITH MAJOR INJURIES. FOR SAFE USE OF THIS PRODUCT, YOU MUST READ AND FOLLOW ALL INSTRUCTIONS BEFORE USE.

### PRE-USE SPRAYER SAFETY INSPECTION:

1. Check tightness of hose clamp with screwdriver to be sure hose is securely attached to the tank outlet nipple.
2. Inspect hose for deterioration, cracks, softness or brittleness. If any of these conditions are found, replace hose before using. Replace with original manufacturer's parts only.
3. Remove pump (SEE PRESSURE RELEASE INSTRUCTIONS.)
4. Inspect interior and exterior of tank for signs of deterioration (i.e. rust, cracks, bubbling and/or pitting) of body and bottom. Any sign of deterioration indicates possible tank weakening and could result in explosive bursting under pressure. If any of these signs are found, DISCARD TANK IMMEDIATELY AND REPLACE.

**CAUTION:** DO NOT ATTEMPT TO PATCH LEAKS, ETC. AS THIS COULD RESULT IN SERIOUS INJURY.

5. For pressure testing and sprayer use familiarization. FOLLOW FILLING INSTRUCTIONS EXCEPT: Use water only.
6. FOLLOW PRESSURIZATION INSTRUCTIONS EXCEPT, pump plunger only 8-10 strokes and inspect for leaks.
7. After inspection is completed, pump plunger until it works hard and lock handle.
8. (FOLLOW SPRAYING INSTRUCTIONS) Verify desired spraying patterns and practice spraying.
9. If unit passes this test, release pressure (SEE PRESSURE RELEASE INSTRUCTIONS.)
10. Empty tank.
11. PROCEED WITH FILLING, PRESSURIZING AND SPRAYING INSTRUCTIONS WITH DESIRED CHEMICAL SOLUTION.

### WARNING

NEVER SPRAY FLAMMABLE MATERIALS; ALWAYS READ CHEMICAL LABEL BEFORE FILLING SPRAYER, AS SOME CHEMICALS MAY BE HAZARDOUS WHEN USED WITH THIS SPRAYER.

### FILLING INSTRUCTIONS:

1. To engage handle in lock position: Push handle down to completely compress spring and rotate handle 1/4 turn clockwise, then allow handle to raise into lock position.
2. To remove pump engage handle in locked position and turn pump handle down to completely compress spring and rotate handle 1/4 turn clockwise, then allow handle to raise into lock position.
3. Prepare spray solution following directions on chemical container label.
4. Strain solution to remove foreign particles, which can clog sprayer nozzle.
5. Fill tank to indicated or desired useable capacity, leaving remaining space for compressed air (SEE FRONT PAGE OF MANUAL FOR THE MAXIMUM USEABLE CAPACITY).
6. Check pump barrel to be sure no dirt or grass is stuck to barrel.
7. Place pump into tank opening and rotate clockwise until tightly locked and sealed into tank opening.

### PRESSURING INSTRUCTIONS:

1. Disengage handle from locked position by pushing down and turning 1/4 turn counter-clockwise to release handle.

**CAUTION:** TO PREVENT EJECTED PUMP ASSEMBLY AND/OR SOLUTION FROM STRIKING AND INJURING YOU, NEVER STAND WITH FACE OR BODY OVER TOP OF TANK WHEN PUMPING OR LOOSENING PUMP.

**CAUTION:** NEVER PRESSURIZE SPRAYER BY ANY MEANS OTHER THAN THE ORIGINAL PUMP.

2. TO PRESSURIZE TANK: Pump plunger up and down until it works hard.
3. Engage handle in lock position.

### WARNING

**THIS SPRAYER IS NOW UNDER PRESSURE AND DANGEROUS.**

### SPRAYING INSTRUCTIONS

1. Always wear protective goggles, gloves, long sleeve shirt, long pants and sturdy foot protection.
2. Point nozzle away from you.
3. Squeeze shut-off handle to open and adjust nozzle to desired spray pattern by rotating nozzle cap (not complete nozzle) clockwise from fine spray to solid stream (maximum 2 turns).

### WARNING

TURNING NOZZLE CAP TOO FAR WILL RESULT IN CAP FLYING OFF ALLOWING SPRAY MATERIAL TO SPRAY BACK ON YOU. Re-pump unit as required to maintain spray force.

**CAUTION:** Do not leave a pressurized sprayer in the hot sun. Heat can cause pressure build-up.

### PRESSURE RELEASE INSTRUCTIONS:

#### WARNING

To safely release pressure in tank and avoid possibility of injury follow steps 1 through 4 COMPLETELY LISTED BELOW.

1. Place unit on its side with top directed away from you and with hose outlet on top.
2. Direct nozzle away from you and open shut-off allowing spray solution in discharge assemble and remaining air pressure to be completely exhausted.
3. Turn sprayer up right.
4. Remove pump (FOLLOW STEPS 1 AND 2 OF FILLING INSTRUCTION) while maintaining position of top of sprayer directed away from you.

### CLEANING SPRAYER AFTER USE:

1. Rinse tank thoroughly with clear water.
2. Empty tank.
3. Refill tank with clear water.
4. Check pump barrel to be sure no dirt or grass is stuck to barrel.
5. Place pump into tank opening and rotate clockwise until tightly locked and sealed in tank opening.
6. Disengage handle from locked position by pushing down and turning 1/4 turn counter-clockwise to release handle.
7. Pump plunger up and down 8-10 strokes.
8. Open shut-off and allow water to run throughout to clean discharge assembly.
9. Release pressure (FOLLOW PRESSURE RELEASE INSTRUCTIONS).
10. Remove pump.
11. Empty sprayer.
12. REPEAT STEPS 1-11 IF NECESSARY.

### SPRAYER MAINTENANCE:

1. Periodically remove nozzle and extension tube from shut-off.
2. With shut-off discharge hole pointing upward, place 6-8 drops of light oil into discharge hole then depress lever.
3. Piston cup should be periodically greased.
4. If nozzle clogs:
  - A. Remove complete nozzle assembly.
  - B. Disassemble nozzle.
  - C. Clean openings of any obstructions
5. Never use any tool to remove pump if there is pressure in sprayer.

### SPRAYER STORAGE:

1. Sprayer tank should be hung upside down with pump removed in a warm dry location.
2. Do not store or leave any solution in tank after use.

**CAUTION:** DO NOT ATTEMPT TO MODIFY OR REPAIR THIS PRODUCT EXCEPT WITH ORIGINAL MANUFACTURER'S PARTS.

### TROUBLESHOOTING

#### Sprayer leaks at closure

- LOOK FOR:**
1. Sediment or foreign particles on surface of pump gasket or closure surface
  2. Chipped, torn swollen defective pump gasket.
- REMEDY:**
1. Clean all foreign particles from pump gasket and closure surface.
  2. Remove old gasket and replace with new.

**Spray material overflows through pump barrel or pump handle rises when handle is unlocked.**

- LOOK FOR:** Sediment or foreign particles under check valve or chipped, torn, or swollen pump check valve.

**REMEDY:** Remove pump, clean check valve and pump valve seat if necessary.

#### Hose leaks at tank.

- LOOK FOR:**
1. Loose hose clamp.
  2. Cracked hose.
- REMEDY:**
1. Tighten hose clamp.
  2. Replace hose.

#### Poor spray pattern, partial spray or complete stoppage.

- LOOK FOR:**
1. Spray extension, nozzle, or shut-off plugged.
- REMEDY:**
1. Remove nozzle and clean.
  2. Remove extension and clean
  3. Depressurize tank, remove lever and unscrew retainer from shut-off. Remove diaphragm and clean inside of shut off. See assembly and disassembly.

#### Hose leaks at shut-off

- LOOK FOR:** Swollen, split or faulty hose
- REMEDY:** Replace hose

#### Sprayer pumps hard

- LOOK FOR:** Plunger cup dry
- REMEDY:** Grease plunger cup

#### Sprayer pump does not compress air.

- LOOK FOR:** Damaged plunger cup.
- REMEDY:** Replace with new pump or rod assembly.

**Nozzle drips when spray control valve is shut-off.**

**LOOK FOR:** Dirt in shut-off valve or worn out diaphragm.

**REMEDY:** 1. Depressurize tank. Remove lever and unscrew retainer from shut-off.  
2. Remove diaphragm and clean inside of shut-off. Replace diaphragm if swollen or torn. Replace spring if broken. See assembly and disassembly.

**Sprayer tank leaks.**

**LOOK FOR:** Evidence of spray material escaping tank.

**REMEDY:** Replace tank.

**Syphon tube leaks.**

**LOOK FOR:** When spray shut-off valve is opened, tank air pressure is released through nozzle before tank is empty.

**REMEDY:** On stainless steel units – replace tank. On plastic unit, replace removable plastic syphon tube. See hints below for plastic sprayer pump unit.

To release handle push handle down to depress coil spring and turn handle counter-clockwise 1/2 turn, then lift handle.

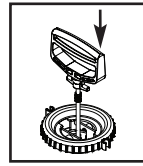

To lock handle, push handle down, to depress coil spring and turn handle 1/4 turn clockwise then allow handle to rise into lock position.

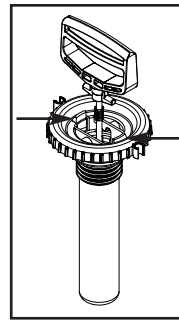
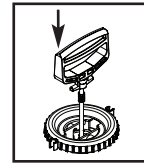

To dislodge pump barrel from cap, push the 2 ears forward and down through the cap. Make sure pump cup is well greased.

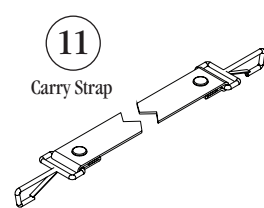
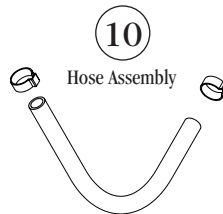
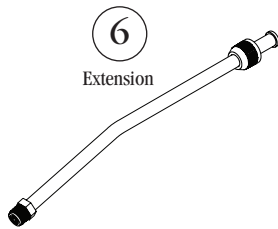
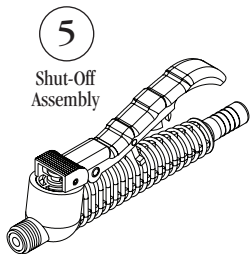
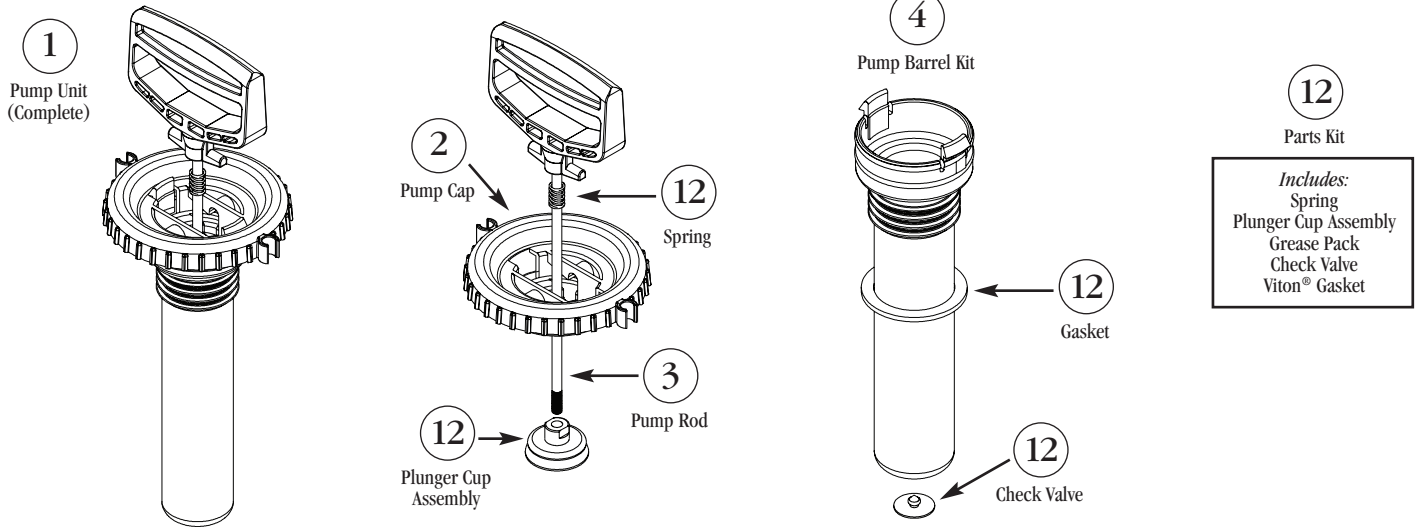

Item #	Part #	Description
1	43000366	Pump Unit (Complete)
2	43000371	Pump Cap
3	43000249	Pump Rod
4	43000601	Pump Barrel Kit
5	43000282	Shut-Off Assembly
6	43000245	Plastic Extension 18"
7	43083601	Spray Tip Pin to Cone (Standard)
8	42032149	Celcon Fan Spray Tip (Available)
9	42033101	Tip Cap (Available)
10	43000234	Hose Assembly 40" with 1 clamp
11	43000052	Carry Strap
12	43000260	Parts Kit